

United States Patent Office.

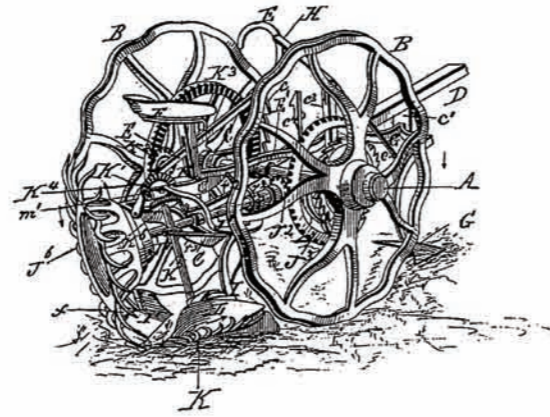
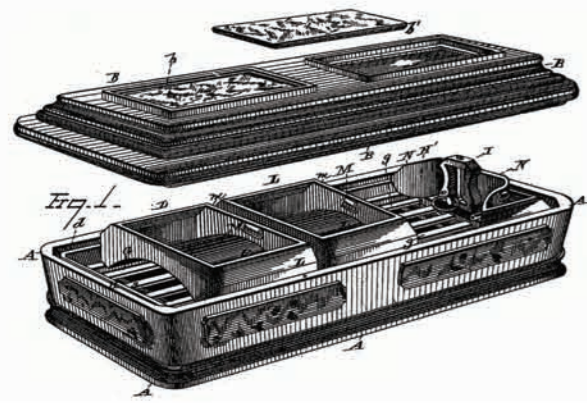

INVENTED IN SARATOGA COUNTY

Although many of the inventors and inventions of Saratoga County have been forgotten, their stories are woven into the fabric of its history. Within these pages are detailed accounts of:

- the Saratoga Chip (now known as the potato chip)
- the development of Standard Time
- Theodore Timby and how he helped to win the Civil War
- Ransom Cook's world renowned auger bit, inspired by a beetle
- the sound machines of Waterford's Henry Miller
- one of the world's largest paper mills and its inventive manager
- Lysander Button's famous hand fire engines
- how the square-bottomed paper bag was created
- America's first copyrighted residence
- the casket that protected the body of President Ulysses S. Grant

...and dozens of other wonderful inventions, all developed and used in Saratoga County, New York.

INVENTED IN SARATOGA COUNTY

TIMOTHY STARR

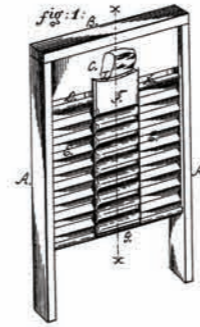

Ransom Cook

INVENTED IN SARATOGA COUNTY

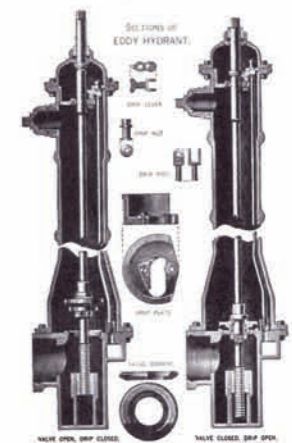
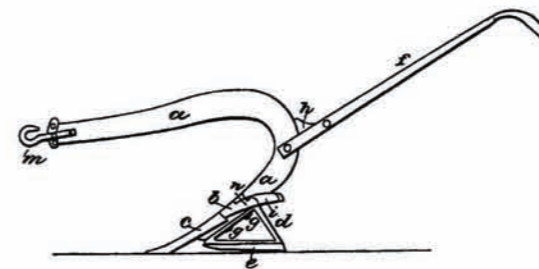
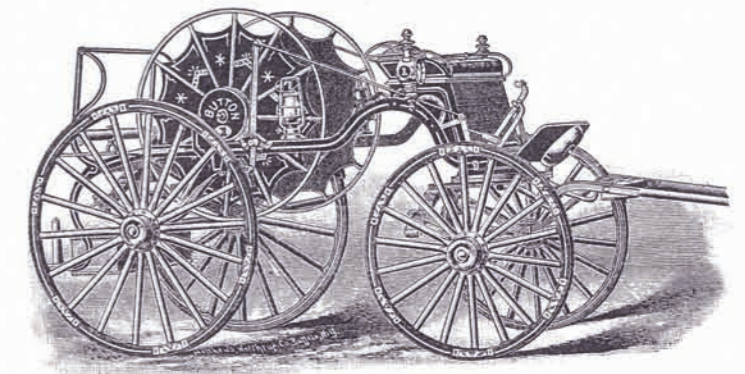
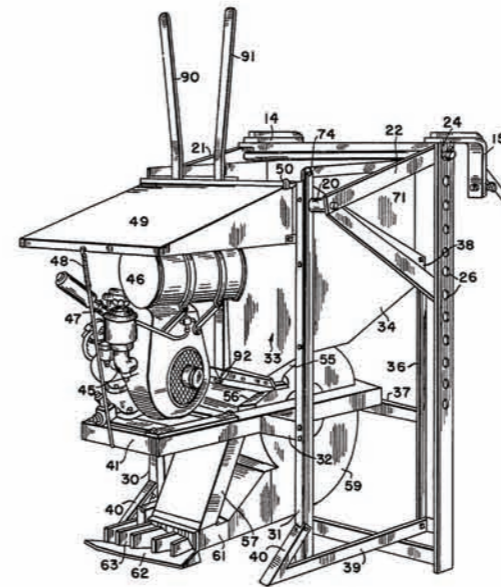

FIG. 140.—Eddy Fire Hydrant.

TIMOTHY STARR